

Magnetic Induction

MOTIONAL EMF

Consider a wire moving across the magnetic fields, for example

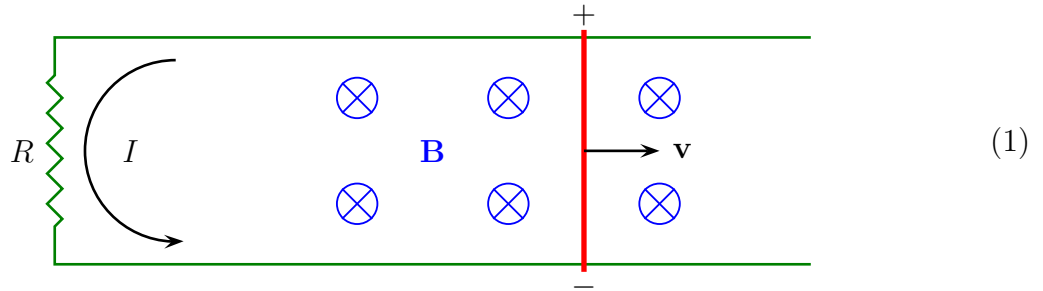

The wire's velocity adds to the velocities of the conducting electrons relative to the wire,

$$\mathbf{v} = \mathbf{v}_{\text{wire}} + \mathbf{v}_{\text{rel}} \quad (2)$$

hence the magnetic Lorentz force on an electron is

$$\mathbf{F} = (-e)\mathbf{v}_{\text{wire}} \times \mathbf{B} + (-e)\mathbf{v}_{\text{rel}} \times \mathbf{B}. \quad (3)$$

When we sum these forces over the conducting electrons, the terms due to \mathbf{v}_{rel} add up to the net mechanical force on the wire,

$$\mathbf{F}_{\text{mech}} = \sum (-e)\mathbf{v}_{\text{rel}} \times \mathbf{B} = (-e)N_e\mathbf{v}_{\text{drift}} \times \mathbf{B} = I\mathbf{L} \times \mathbf{B}. \quad (4)$$

On the other hand, the forces $(-e)\mathbf{v}_{\text{wire}} \times \mathbf{B}$ make the electrons move along the wire in the direction of $-\mathbf{v}_{\text{wire}} \times \mathbf{B}$, which makes the current flow in the opposite direction of $+\mathbf{v}_{\text{wire}} \times \mathbf{B}$. For example, in the red moving wire on the diagram (1), the force pushes the electrons down, so the current flows up. The electromotive “force” generating this current obtains as the work of the magnetic force per unit of charge; for each electron moving all the way from one end of the wire to the other end, the work is

$$W = \mathbf{L} \cdot (\mathbf{F} = (-e)\mathbf{v}_{\text{wire}} \times \mathbf{B}), \quad (5)$$

hence EMF

$$\mathcal{E} = \frac{W}{(-e)} = \mathbf{L} \cdot (\mathbf{v}_w \times \mathbf{B}) \quad (6)$$

where \mathbf{L} is the vector length of the wire. This EMF due to moving a wire across a magnetic field is called the *motional EMF*.

Note: we do not have to wait until a specific electron moves all the way from one end of the wire to the other end. The same work per unit of charge flowing through the wire obtains when the electron gas in the wire collectively moves just a tiny distance along the wire; indeed, such a collective motion is mathematically equivalent to a small fluid element of the electron gas moving the whole distance while the rest of the gas stays in place.



Equation (6) can be easily generalized to curved wires moving in complicated ways through non-uniform magnetic fields,

$$\mathcal{E} = \int_{\text{wire}} (\mathbf{v}_{\text{wire}}(\mathbf{r}) \times \mathbf{B}(\mathbf{r})) \cdot d\mathbf{r}, \quad (7)$$

or even to thick conductors which do not look like wires. For example, consider the Faraday's disk — the earliest lab model of a DC electric generator:

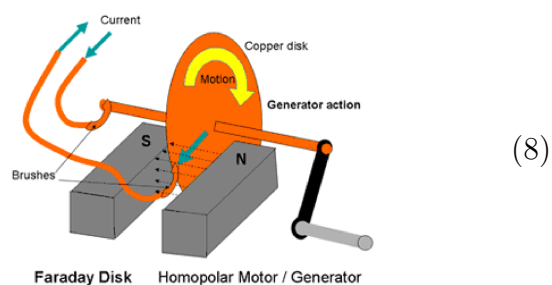
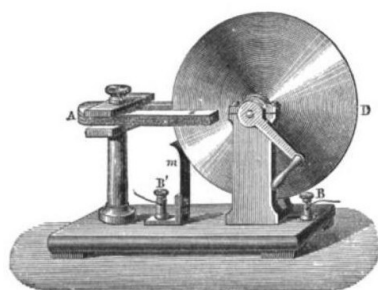

A conducting disk is rotated around its axis with angular velocity ω , so a part of the disk at distance s from the axis moves at velocity $\mathbf{v} = \omega s \hat{\phi}$. In a magnetic field parallel to the axis, this makes for

$$\mathbf{v} \times \mathbf{B} = B\omega s \hat{s} \quad (9)$$

so if we attach one electrode to the disk's axis and the other electrode to a brush sliding

along the disk's rim, we get EMF

$$\mathcal{E} = \int_{\text{axis}}^{\text{rim}} B\omega s \hat{s} \cdot d\vec{\ell} = \int_0^{\text{radius}} ds B\omega s. \quad (10)$$

For a uniform magnetic field across the disk, this integral evaluates to

$$\mathcal{E} = B \times \omega \times \frac{\text{radius}^2}{2} \quad (11)$$

For example, for a disk of radius 10 cm rotating at $\omega = 380$ rad/s (about 3600 RPM) in magnetic field of 1 Tesla, the EMF comes to 1.9 Volt.

A good lab model of an AC electric generator is a loop or coil of wire rotating in a magnetic field, with rotation axis \perp the coil's axis, for example

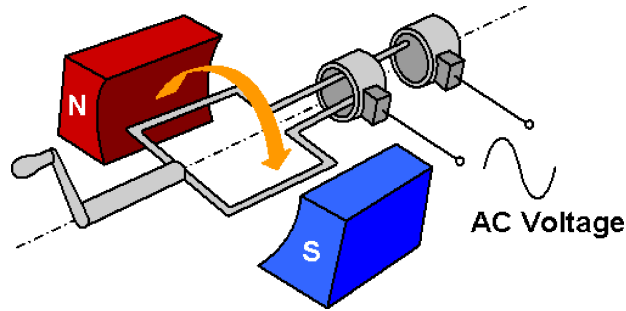

(12)

For a simple rectangular loop shown on this picture one may calculate the AC EMF directly from eq. (6), but for more realistic wire coils one has to use eq. (7), and the integral over the moving coil's length can be quite painful to evaluate. Fortunately, there is a much-easier-to-evaluate formula for the motional EMF in terms of the magnetic flux.

Consider a complete circuit involving some moving wires in a magnetic field, as well as some non-moving wires (and other circuit elements) through which the current flows back to the moving wires. Let \mathcal{L} be the closed loop in space made by all these wires, and let Φ be the magnetic flux through that loop. As the wires move, the geometry of the loop changes with time, which makes the magnetic flux change with time,

$$\Phi(t) = \Phi[\text{through } \mathcal{L}(t)] \neq \text{const}, \quad (13)$$

Theorem: the motional EMF through the circuit \mathcal{L} is related to the rate of the flux (13) changing with time,

$$\mathcal{E} = \oint_{\mathcal{L}} (\mathbf{v}_w \times \mathbf{B}) \cdot d\vec{\ell} = -\frac{d}{dt} \Phi[\text{through } \mathcal{L}(t)]. \quad (14)$$

Proof: Technically, the magnetic flux through a loop \mathcal{L} is defined as a surface integral over a surface \mathcal{S} *spanning* the loop \mathcal{L} ,

$$\Phi[\text{through } \mathcal{L}] = \iint_{\mathcal{S}} \mathbf{B} \cdot d^2\mathbf{a}. \quad (15)$$

The reason we call it the flux through \mathcal{L} without specifying the surface \mathcal{S} is that the flux through all surfaces spanning the same loop \mathcal{L} is exactly the same — this is assured by the magnetic Gauss law $\nabla \cdot \mathbf{B} = 0$ and the Gauss theorem.

Now, consider two successive snapshot pictures of the moving loop $\mathcal{L}(t)$, the \mathcal{L}_1 at time t_1 and the \mathcal{L}_2 at a later time t_2 . Let \mathcal{S}_1 be some surface spanning the \mathcal{L}_1 while $\Delta\mathcal{S}$ is a ribbon-shaped surface connecting the two loops as shown on the picture below

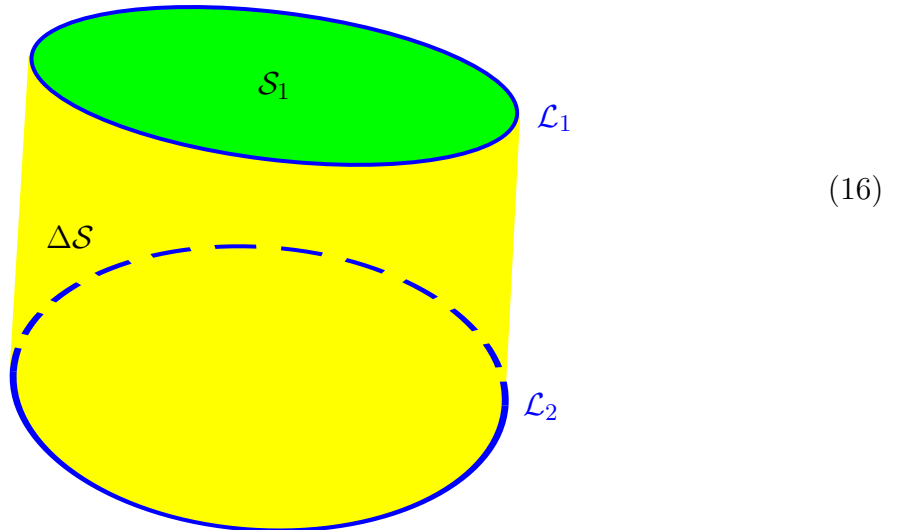

The combined surface $\mathcal{S}_2 = \mathcal{S}_1 + \Delta\mathcal{S}$ spans the loop \mathcal{L}_2 ; it might look like a peculiar choice of a surface to span the loop \mathcal{L}_2 at time t_2 , but it does the job. Consequently, the magnetic

flux at time t_2 can be calculated using this surface, thus

$$\Phi(t_2) = \iint_{S_1+\Delta S} \mathbf{B} \cdot d^2\mathbf{a} = \iint_{S_1} \mathbf{B} \cdot d^2\mathbf{a} + \iint_{\Delta S} \mathbf{B} \cdot d^2\mathbf{a} = \Phi(t_1) + \iint_{\Delta S} \mathbf{B} \cdot d^2\mathbf{a}. \quad (17)$$

Therefore, the change of the magnetic flux through a moving loop can be expressed as the integral over the ribbon ΔS ,

$$\Delta\Phi = \Phi(t_2) - \Phi(t_1) = \iint_{\Delta S} \mathbf{B} \cdot d^2\mathbf{a}. \quad (18)$$

Let's focus on very short time intervals $\Delta t = t_2 - t_1 \rightarrow 0$, so the loops \mathcal{L}_1 and \mathcal{L}_2 are very close to each other. As each infinitesimal piece $d\vec{\ell}$ of wire moves from its old place in \mathcal{L}_1 to its new place in \mathcal{L}_2 with velocity \mathbf{v} , it sweeps through area

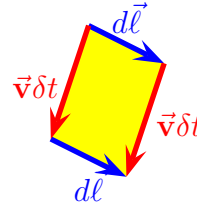

$$d^2\mathbf{a} = \vec{v}\delta t \times d\vec{\ell}. \quad (19)$$

As to the whole moving loop $\mathcal{L}(t)$, it sweeps through a very narrow ribbon

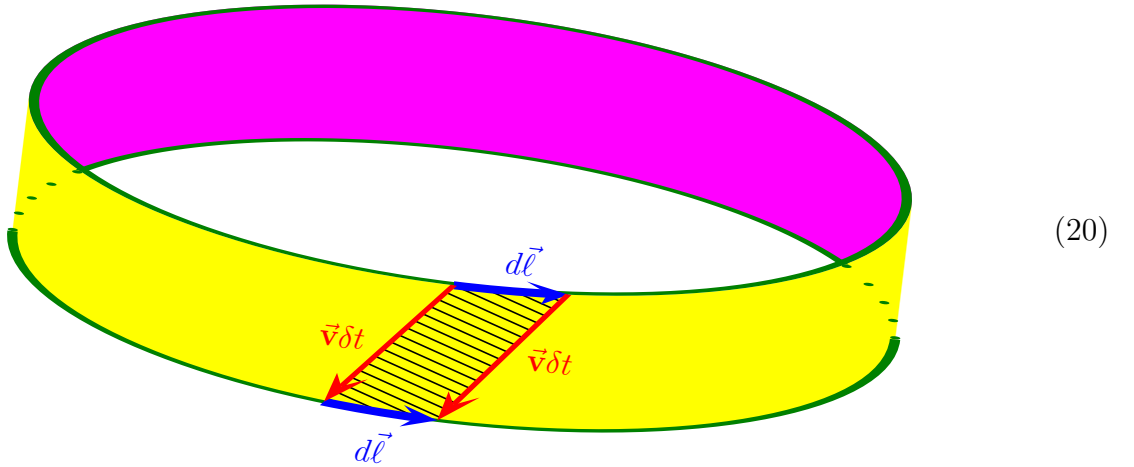

which we may identify as ΔS . The vector area of this ribbon is

$$\mathbf{a} = \oint_{\mathcal{L}} \mathbf{v}\delta t \times d\vec{\ell} \quad (21)$$

where the velocity vector \mathbf{v} may vary along the loop, depending on how the wires are moving.

The magnetic flux through the ribbon $\Delta\mathcal{S}$ follows from the infinitesimal areas (19):

$$\iint_{\Delta\mathcal{S}} \mathbf{B} \cdot d^2\mathbf{a} = \oint_{\mathcal{L}} \mathbf{B} \cdot (\mathbf{v}\delta t \times d\vec{\ell}) = -\delta t \times \oint_{\mathcal{L}} (\mathbf{v} \times \mathbf{B}) \cdot d\vec{\ell}, \quad (22)$$

where the second equality follows from the vector identity

$$\mathbf{B} \cdot (\mathbf{v} \times d\vec{\ell}) = d\vec{\ell} \cdot (\mathbf{B} \times \mathbf{v}) = -(\mathbf{v} \times \mathbf{B}) \cdot d\vec{\ell}. \quad (23)$$

But as we saw earlier in eq. (18), the magnetic flux through the ribbon $\Delta\mathcal{S}$ is precisely the change of the magnetic flux through the moving loop \mathcal{L} between times t_1 and $t_2 = t_1 + \delta t$. Consequently, *the rate of change of the magnetic flux through the moving loop* obtains from eq. (22) as

$$\frac{d\Phi}{dt} = - \oint_{\mathcal{L}} (\mathbf{v} \times \mathbf{B}) \cdot d\vec{\ell}. \quad (24)$$

Finally, after all these manipulations of the magnetic flux, let's go back to the motional EMF in the circuit loop \mathcal{L} . Extending the integral in eq. (7) over the moving wires to the integral over the whole circuit, we have

$$\mathcal{E} = \oint_{\mathcal{L}} (\mathbf{v} \times \mathbf{B}) \cdot d\vec{\ell}. \quad (25)$$

By inspection, this is precisely the RHS of eq. (24), up the overall sign, thus

$$\mathcal{E} = -\frac{d\Phi}{dt} \quad (14)$$

— the motional EMF in a moving circuit is precisely (minus) the rate of change of the magnetic flux through the circuit due to its motion. *Quod erat demonstrandum.*

As an example of using the *flux rule* (14), consider a toy AC generator — a coil of N loops, each of area A , rotating in uniform magnetic field B . The magnetic flux through this coil is

$$\Phi = NA \times B \times \cos(\alpha), \quad (26)$$

where α is the angle between the coil's axis and the magnetic field. For the rotation axis which is \perp to the coil's axis and also \perp to the magnetic field, $\alpha = \omega \times t$ where ω is the

rotation frequency, hence

$$\Phi(t) = NA \times B \times \cos(\omega t). \quad (27)$$

By the flux rule (14), this gives us the motional EMF in the rotating coil as

$$\mathcal{E}(t) = -\frac{d}{dt} (NAB \cos(\omega t)) = +NAB\omega \times \sin(\omega t). \quad (28)$$

For example, for $N = 1000$ loops, $A = 4.5 \text{ cm}^2$, $B = 1.0 \text{ T}$, and $\omega = 2\pi \times 60 \text{ Hz}$, we generate AC EMF with amplitude $NAB\omega = 170\text{V}$, similar to the electric grid voltage in USA.

FARADAY'S LAW OF INDUCTION

Back in 1831, Michael Faraday reported a series of experiments on using magnets and motion to *induce* an EMF in a circuit and make a current flow through it. Among other methods, he induced an EMF in a wire coil by means of:

1. Moving the coil towards a magnet or away from a magnet.
2. Keeping the coil stationary while moving the magnet towards the coil or away from it.
3. Keeping the coil stationary near a stationary electromagnet, and varying the current through the magnet (and hence the magnetic field it makes).

As we have seen earlier in these notes, the EMF induced by the first method is the motional EMF, ultimately stemming from the Lorentz forces on the electrons in the moving wires. But the physics underlying the other two methods seems to be quite different: Moving a magnet or varying the current through an electromagnet makes a *time-dependent magnetic field, which induces a non-potential electric field* (as I shall explain in a moment); it is this non-potential electric field which gives rise to the EMF induced in the stationary loop.

But despite seemingly different physical origins, all Faraday's methods of *magnetic induction* operate according to the same *flux rule*, usually called the *Faraday's Law of Induction*: *Whenever — and for whatever reason — the magnetic flux through an electric circuit changes, it induces EMF in the circuit according to*

$$\mathcal{E} = -\frac{d\Phi}{dt}. \quad (29)$$

BTW, while the physical origins of methods 1 and 2+3 *seem* to be quite different — the Lorentz force versus the force of the induced electric field — they are related to each other by special relativity. In fact, it was Albert Einstein’s investigation of how methods 1 and 2 induce exactly the same EMF for the same *relative* motion of the coil and the magnet which lead him to the special relativity theory in the first place!

As an example of the Faraday’s Law (29), consider moving a long thin bar magnet through a coil of wire not much wider than the magnet. As the magnet is inserted into the loop, the flux through the loop increases from zero to the maximal value $B_{\text{magnet}} \times A_{\text{magnet}}$, then it stays constant as the magnet moves through the loop, and when the magnet exits from the loop, the flux drops back to zero:

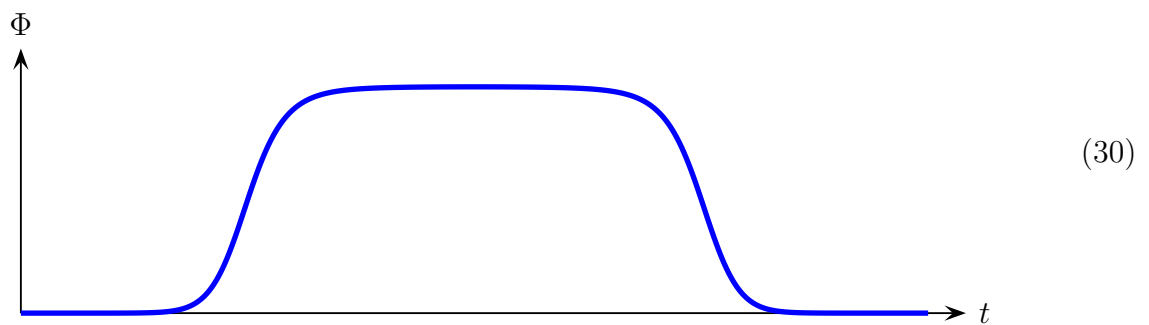

By the Faraday’s Law (29), this flux produces two pulses of EMF, first a negative pulse when the magnet enters the loop, and then a positive pulse when the magnet exits,

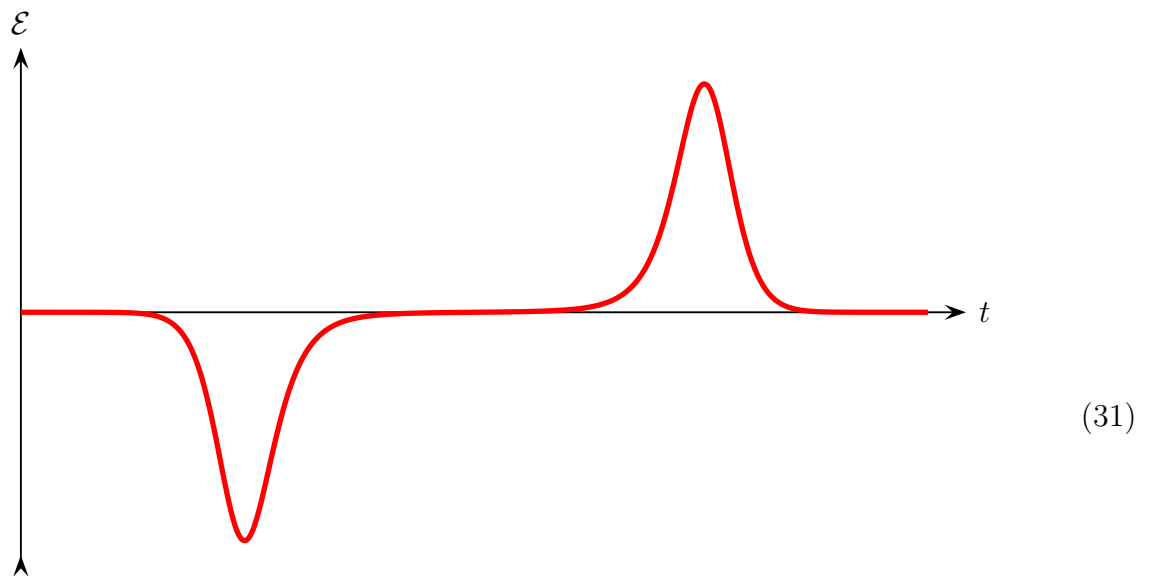

Next, consider the *direction* of the induced EMF. The minus sign in the flux formula (29) encodes the *Lenz rule: The current due to the induced EMF tries to counteract the change of the flux which has induced the EMF*. Philosophically speaking, *Nature abhors changing magnetic fluxes*. For example, suppose you have an upward magnetic field through a horizontal loop of wire. If the upward field increases, the increasing magnetic flux through the loop induces a clockwise EMF in the loop, which causes a clockwise current generating a downward magnetic field. (Note the right hand rule.) This downward field of the current in the loop *tries* to counteract the increasing flux of the external upward field. Likewise, when the external upward field decreases, the decreasing flux induces a counterclockwise EMF, hence a counterclockwise current in the loop generating an upward magnetic field, — which *tries* to counteract the decrease of the external upward field. (In both cases, the current in the loop due to the induced EMF does not completely counteract the changes on the magnetic flux through the loop, it only tries to do so, and the flux it generates may be only a tiny part of the changing flux of the external field. But the very fact that it tries to counteract the flux change gives us the direction of the induced EMF, and that all the Lenz rule is good for.)

As an example of the Lenz rule in action, consider the [Jumping Ring demo](#) you should have seen back in the freshmen E&M class: Put a thick aluminum ring on top of a vertical solenoid, then suddenly turn on the current through the solenoid. This makes for a sudden increase of the magnetic flux through the ring, hence a strong pulse of induced EMF, and since the thick aluminum ring has very low electric resistance, you get very strong current flowing through the ring. By the Lenz rule, the direction of this current is opposite to the direction of the current through the solenoid. But the currents flowing in opposite directions repel each other, which means a strong upward force on the ring. And indeed, when I had turned on the current on in the demo, the ring flew up a few meters above the solenoid, almost to the ceiling.

THE INDUCED ELECTRIC FIELD

Let's take another look at the magnetic flux through a loop of moving wires, but now allow for a time-dependent magnetic field $\mathbf{B}(x, y, z; t)$ in addition to the time dependent loop

geometry $\mathcal{L}(t)$. Taking the total time derivative, we have

$$\frac{d\Phi}{dt} = \frac{d}{dt} \iint_{S(t)} \mathbf{B}(\mathbf{r}, t) \cdot d^2\mathbf{a} = \iint_{\partial S/\partial t} \mathbf{B} \cdot d^2\mathbf{a} + \iint_S \frac{\partial \mathbf{B}}{\partial t} \cdot d^2\mathbf{a}, \quad (32)$$

where the first term is due to motion of the wire loop while the second term is due to time-dependence of the field. In terms of the EMF induced in the circuit, eq.(32) becomes

$$\mathcal{E}_{\text{net}} = -\frac{d\Phi}{dt} = \mathcal{E}_{\text{motion}} + \mathcal{E}_{\text{var.b}} \quad (33)$$

where

$$\mathcal{E}_{\text{motion}} = -\iint_{\partial S/\partial t} \mathbf{B} \cdot d^2\mathbf{a} = \oint_{\mathcal{L}} (\mathbf{v} \times \mathbf{B}) \cdot d\vec{\ell} \quad (34)$$

is the motional EMF we have explored in the first section of these notes, while

$$\mathcal{E}_{\text{var.B}} = -\iint_S \frac{\partial \mathbf{B}(\mathbf{r}, t)}{\partial t} \cdot d^2\mathbf{a} \quad (35)$$

is the extra EMF due to time-dependence of the magnetic field.

Physically, this extra EMF stems from the *electric field induced by the $\partial \mathbf{B}/\partial t$* . Unlike the electrostatic field, the induced electric field is non-conservative (or rather, the force $\mathbf{F} = q\mathbf{E}_{\text{induced}}$ is non-conservative), so it has non-zero line integrals along closed loops,

$$\oint \mathbf{E}_{\text{static}} \cdot d\vec{\ell} = 0 \quad \text{but} \quad \oint \mathbf{E}_{\text{induced}} \cdot d\vec{\ell} \neq 0. \quad (36)$$

Indeed, it's the non-zero work of the induced electric field pushing the electrons around some wire loop \mathcal{L} which provides the EMF in a time-dependent magnetic field, thus

$$\oint_{\mathcal{L}} \mathbf{E}_{\text{induced}} \cdot d\vec{\ell} = \mathcal{E}_{\text{var.B}} = -\iint_S \frac{\partial \mathbf{B}(\mathbf{r}, t)}{\partial t} \cdot d^2\mathbf{a}. \quad (37)$$

This is a global form of the Ampere-like law for the induced electric field. In the local form, this becomes the *Induction Law*

$$\nabla \times \mathbf{E}_{\text{induced}} = -\frac{\partial \mathbf{B}}{\partial t}. \quad (38)$$

As an example of an induced electric field, consider a long solenoid powered by a time-dependent current $I(t)$. In cylindrical coordinates, the magnetic field of the solenoid is

$$\mathbf{B}(s, \phi, z; t) = \begin{cases} \mu_0(N/L) I(t) \hat{\mathbf{z}} & \text{for } s < a, \\ 0 & \text{for } s > a, \end{cases} \quad (39)$$

where N/L is the density of the solenoid's winding and a is its radius. Consequently, on the RHS of eqs. (37) and (38) we have

$$-\frac{\partial \mathbf{B}}{\partial t} = \begin{cases} -\mu_0(N/L) (dI/dt) \hat{\mathbf{z}} & \text{for } s < a, \\ 0 & \text{for } s > a, \end{cases} \quad (40)$$

which looks exactly like the current density \mathbf{J} in a round wire, where

$$-\frac{d\Phi[\text{solenoid}]}{dt} = -\mu_0(N/L) \times \frac{dI}{dt} \times \pi a^2 \quad (41)$$

plays the role of the net current I in the wire. Consequently, we may find the induced electric field both inside and outside the solenoid from the Ampere-like formula (37).

Indeed, the symmetries of the long solenoid and its magnetic field — translations along the z axis, rotations about z axis, and the reflection $z \rightarrow -z$ — require the induced electric field to point in the $\hat{\phi}$ direction around the solenoid while its magnitude depends only on the cylindrical radius s ,

$$\mathbf{E}(s, \phi, z; t) = E(s; t) \hat{\phi}, \quad (42)$$

just like the magnetic field of a thick wire. Thus, for the circular Ampere loop of radius s centered on the solenoid's axis,

$$\oint \mathbf{E} \cdot d\vec{\ell} = 2\pi s \times E(s; t), \quad (43)$$

while the time derivative of the magnetic flux through the loop is

$$\frac{d\Phi}{dt} = \mu_0(N/L) \times \frac{dI}{dt} \times \begin{cases} \pi s^2 & \text{for } s < a, \\ \pi a^2 & \text{for } s > a. \end{cases} \quad (44)$$

Consequently,

$$\text{inside the solenoid, for } s < a, \quad \mathbf{E} = -\mu_0(N/L) \frac{dI}{dt} \frac{s}{2} \hat{\phi}, \quad (45)$$

$$\text{outside the solenoid, for } s > a, \quad \mathbf{E} = -\mu_0(N/L) \frac{dI}{dt} \frac{a^2}{2s} \hat{\phi}. \quad (46)$$

Here is the picture of the electric field lines described by these formulae:

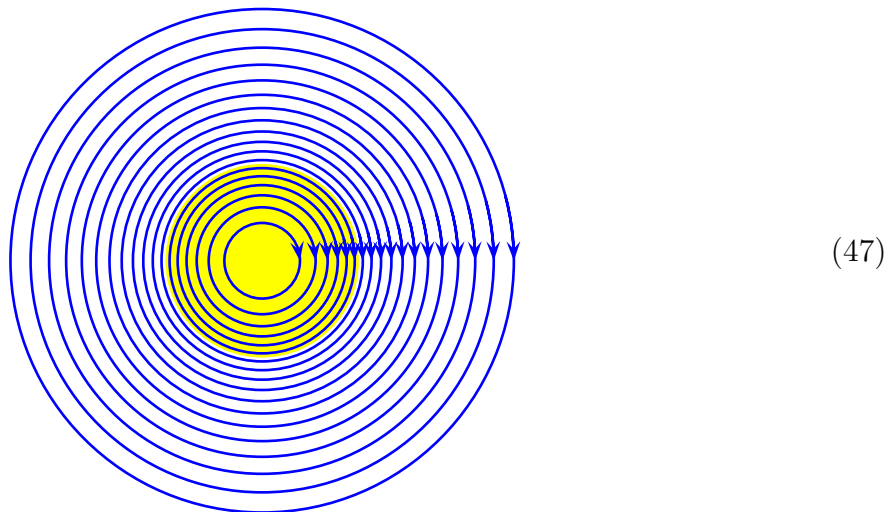

Note that while the magnetic field itself is confined to the inside of the solenoid, its time-dependence induces the electric field both inside and outside the solenoid. (Yellow vs. white background on the above picture.)

In more general situations without symmetries, the induced electric field obtains from solving the differential equations

$$\nabla \cdot \mathbf{E} = \frac{\rho}{\epsilon_0}, \quad \nabla \times \mathbf{E} = -\frac{\partial \mathbf{B}}{\partial t}. \quad (48)$$

In the absence of electric charges — for $\rho(\mathbf{r}, t) \equiv 0$ — these equations are mathematically similar to the equations

$$\nabla \cdot \mathbf{B} = 0, \quad \nabla \times \mathbf{B} = \mu_0 \mathbf{J} \quad (49)$$

for the magnetic field, so the solutions are also mathematically similar. Thus, we have a Biot–Savart–Laplace–like formula for the induced electric field,

$$\mathbf{E}_{\text{induced}}(\mathbf{r}, t) = -\frac{1}{4\pi} \iiint \frac{\partial \mathbf{B}(\mathbf{r}', t)}{\partial t} \times \frac{\mathbf{r} - \mathbf{r}'}{|\mathbf{r} - \mathbf{r}'|^3} d^3\text{Vol}'. \quad (50)$$

This formula is useful when you know the magnetic field and its time derivative everywhere in space. For example, you can (and should) use it in the homework problem about the electric field induced by the time-dependent magnetic field in a toroidal coil.

CAVEAT: The induced electric field follows from the time-dependent magnetic field $\mathbf{B}(\mathbf{r}, t)$ which in turn follows from the time-dependent currents $I(t)$ in some wires. But finding the magnetic field of a time-dependent current is tricky, since the Ampere's law — and hence the Biot–Savart–Laplace law — apply only to the steady currents which do not change with time. For the time-dependent currents and fields, the Ampere's law should be replaced with the more general Maxwell–Ampere law, which provides among other things for the propagating electromagnetic waves. Consequently, calculating the *exact* magnetic field $\mathbf{B}(\mathbf{r}, t)$ due to time-dependent currents $I(t)$ is very complicated.

Fortunately, for the *slowly* changing currents — which change much slower than the time it takes an EM wave to travel through the region of space we are interested in — we may use the *quasi-static* approximation. In the quasi-static regime, the EM waves generated by the time-dependent currents are negligible compared to the more immediate effects of the currents, and the un-modified Ampere and Biot–Savart–Laplace laws work to a good approximation.

For example, suppose the current $I(t)$ in a solenoid changes on the time scale τ . Then eqs. (39) and (45)–(46) for the magnetic field of the solenoid and the electric field it induces are valid up to a distance $D_{\max} = c\tau$ from the solenoid (where c is the speed of light). At larger distances, the electric field (46) becomes weaker than the EM waves emitted by the solenoid, so eq. (46) is no longer appropriate.

For another example, consider an infinitely long wire carrying a slowly varying current $I(t)$. In the quasi-static approximation, the magnetic field of the wire is

$$\mathbf{B}(\mathbf{r}, t) = \frac{\mu_0 I(t)}{2\pi s} \hat{\phi}, \quad (51)$$

and its time-dependence induces the electric field in the z direction, parallel to the wire. Indeed, by symmetries of the straight wire,

$$\mathbf{E}(\mathbf{r}, t) = E(s, t) \hat{\mathbf{z}}, \quad (52)$$

hence

$$\nabla \times \mathbf{E} = \frac{\partial E(s, t)}{\partial s} \hat{\phi}. \quad (53)$$

Comparing this curl to the magnetic field (51) and its time derivative, we arrive at

$$\frac{\partial E(s, t)}{\partial s} = -\frac{\mu_0}{2\pi s} \frac{dI}{dt} \quad (54)$$

and hence

$$\mathbf{E}(s, t) = \mathbf{E}(a, t) - \mu_0 \frac{dI}{dt} \int_a^s \frac{ds'}{2\pi s'} = \frac{I(t)}{\sigma \times \pi a^2} - \frac{\mu_0}{2\pi} \times \frac{dI}{dt} \times \ln \frac{s}{a}, \quad (55)$$

where the first term is the electric field inside the wire $\mathbf{E}(t) = \mathbf{J}(t)/\sigma$. Note that the second term in this formula becomes infinite for $s \rightarrow \infty$, which cannot possibly be right!

The point of this example is that eq. (55) is based on the quasi-static approximation, which is valid only up to distances $s \lesssim c\tau$. At larger distances, the EM waves take over, eq. (55) becomes inappropriate, so its bad behavior for $s \rightarrow \infty$ is not a real problem, but just an artefact of pushing an approximation beyond the limit of its validity.

THE POTENTIALS AND THE GAUGE TRANSFORMS

The induced electric field has non-zero curl, so it cannot be written as (minus) gradient of some potential, $\mathbf{E} \neq -\nabla V$. Instead, the induced field — or any time dependent electric field, however general — has form

$$\mathbf{E}(\mathbf{r}, t) = -\nabla V(\mathbf{r}, t) - \frac{\partial}{\partial t} \mathbf{A}(\mathbf{r}, t) \quad (56)$$

where $\mathbf{A}(\mathbf{r}, t)$ is the vector potential for the magnetic field,

$$\mathbf{B}(\mathbf{r}, t) = \nabla \times \mathbf{A}(\mathbf{r}, t). \quad (57)$$

Indeed, since nobody has ever seen a magnetic monopole, the magnetic Gauss law calls for zero divergence of the magnetic field, $\nabla \cdot \mathbf{B} \equiv 0$, everywhere and everywhen, regardless if the magnetic field is static or time-dependent. Consequently, at any instance of time t , the (x, y, z) dependent magnetic field is a curl of some vector potential $\mathbf{A}(x, y, z)$, and if the magnetic field is time-dependent, then the vector potential is also time dependent so that the relation (57) holds at all times t .

Now consider the electric field induced by the time-dependent magnetic field. By the induction law,

$$\nabla \times \mathbf{E} = -\frac{\partial \mathbf{B}}{\partial t} = -\frac{\partial}{\partial t}(\nabla \times \mathbf{A}), \quad (58)$$

and since the space derivatives commute with the time derivative,

$$\nabla \times \mathbf{E} = -\nabla \times \left(\frac{\partial \mathbf{A}}{\partial t} \right). \quad (59)$$

Consequently, the combination

$$\mathbf{E}(\mathbf{r}, t) + \frac{\partial \mathbf{A}(\mathbf{r}, t)}{\partial t} \quad (60)$$

has zero curl,

$$\nabla \times \left(\mathbf{E} + \frac{\partial \mathbf{A}}{\partial t} \right) = 0. \quad (61)$$

Therefore, it is this curl-less combination rather than the electric field itself which should be (minus) the gradient of a scalar potential $V(x, y, z)$, or rather $V(x, y, z; t)$ to allow for the time-dependent fields. Thus,

$$\mathbf{E}(\mathbf{r}, t) + \frac{\partial \mathbf{A}}{\partial t} = -\nabla V(\mathbf{r}, t) \quad (62)$$

and hence

$$\mathbf{E}(\mathbf{r}, t) = -\nabla V(\mathbf{r}, t) - \frac{\partial}{\partial t} \mathbf{A}(\mathbf{r}, t). \quad (56)$$

Similar to the static case, the vector potential $\mathbf{A}(x, y, z; t)$ and the scalar potential $V(x, y, z; t)$ are not unique. Statically, the vector potential for a given magnetic field is determined up to a gauge transform

$$\mathbf{A}'(\mathbf{r}) = \mathbf{A}(\mathbf{r}) + \nabla \Lambda(\mathbf{r}) \implies \nabla \times \mathbf{A}'(\mathbf{r}) = \nabla \times \mathbf{A}(\mathbf{r}), \quad (63)$$

for an arbitrary $\Lambda(x, y, z)$. For the time-dependent magnetic fields, we may also use time-dependent gauge transforms with arbitrary $\Lambda(x, y, z; t)$. However, in order to preserve the

electric field (56) as well as the magnetic field, a time-dependent gauge transform also shifts the scalar potential by a time derivative of Λ ,

$$\begin{aligned}\mathbf{A}'(\mathbf{r}, t) &= \mathbf{A}(\mathbf{r}, t) + \nabla\Lambda(\mathbf{r}, t), \\ V'(\mathbf{r}, t) &= V(\mathbf{r}, t) - \frac{\partial\Lambda(\mathbf{r}, t)}{\partial t}, \\ \mathbf{B}'(\mathbf{r}, t) &= \mathbf{B}(\mathbf{r}, t), \\ \mathbf{E}'(\mathbf{r}, t) &= \mathbf{E}(\mathbf{r}, t).\end{aligned}\tag{64}$$

Note that all *physical* quantities are invariant under such gauge transforms. For some convoluted calculations, this is a powerful cross-check of the final results: if they are not gauge invariant, you must have made a mistake somewhere!

In other situations, it's convenient to eliminate the potential's redundancy by fixing a gauge condition, that is, imposing an extra linear condition on the \mathbf{A} and V (one equation for each (\mathbf{r}, t)) to make the potentials unique. A commonly used condition is the transverse gauge $\nabla \cdot \mathbf{A}(\mathbf{r}, t) \equiv 0$, also called the Coulomb gauge because in this gauge the scalar potential $V(\mathbf{r}, t)$ is simply the Coulomb potential due to $\rho(\mathbf{r}', t)$ at the same time t . Indeed, in the transverse gauge

$$\nabla \cdot \mathbf{E} = -\nabla^2 V - \frac{\partial}{\partial t}(\nabla \cdot \mathbf{A}) = -\nabla^2 V,\tag{65}$$

hence by the Gauss Law

$$\nabla^2 V(x, y, z, t) = -\frac{1}{\epsilon_0} \rho(x, y, z, t),\tag{66}$$

which is a differential equation in space but not in time, so its solution is the *instantaneous* Coulomb potential

$$V(\mathbf{r}, t) = \frac{1}{4\pi\epsilon_0} \iiint \frac{\rho(\mathbf{r}', t)}{|\mathbf{r} - \mathbf{r}'|} d^3\text{Vol}'.\tag{67}$$

Another common condition is the Lorentz-invariant Landau gauge

$$\nabla \cdot \mathbf{A} + \mu_0\epsilon_0 \frac{\partial V}{\partial t} = 0\tag{68}$$

in which both the scalar and the vector potentials obey similar wave equations,

$$\left(\frac{1}{c^2} \frac{\partial^2}{\partial t^2} - \nabla^2 \right) V(\mathbf{r}, t) = \frac{1}{\epsilon_0} \rho(\mathbf{r}, t),\tag{69}$$

$$\left(\frac{1}{c^2} \frac{\partial^2}{\partial t^2} - \nabla^2\right) \mathbf{A}(\mathbf{r}, t) = \mu_0 \mathbf{J}(\mathbf{r}, t), \quad (70)$$

$$\frac{1}{c^2} = \mu_0 \epsilon_0. \quad (71)$$

Unfortunately, I would not have time this semester to derive these equations. If you are interested in the electromagnetic waves, please take the second semester of the Classical Electrodynamics class, PHY 352 L.